

## DATA SHEET

### MODULETEK: XFP-10G-ER-x-C10

10GBASE 1550nm Single Mode XFP Optical Transceiver

#### XFP-10G-ER-x-C10 Overview

ModuleTek's XFP-10G-ER-x-C10 10Gb/s optical transceivers are designed for IEEE 802.3ae 10GBASE-ER, 10GBASEEW, 10GFC and OC192 interconnects. The product implements digital diagnostics functions via a 2-wire serial interface, compliant with XFP Multi-Source Agreement (MSA) Specification.

#### Product Features

- Up to 9.95 Gb/s to 11.3 Gb/s bit rates
- Compliant with IEEE 802.3ae, 10GFC, 10GBASE-ER/EW, OC192 application
- Compliant with XFP MSA
- Standard bail mechanism for consistent installation and removal
- Temperature-stabilized 1550nm EML laser
- Receiver with PIN
- Built-in digital diagnostic functions
- Hot Pluggable XFP footprint
- Duplex LC Connectors
- Up to 40km on SMF
- Low power consumption <2.5W
- RoHS Compliant
- Operating temperature range (Case Temperature) :  
Commercial Level : 0°C to 70°C  
Industrial Level : -40°C to 85°C

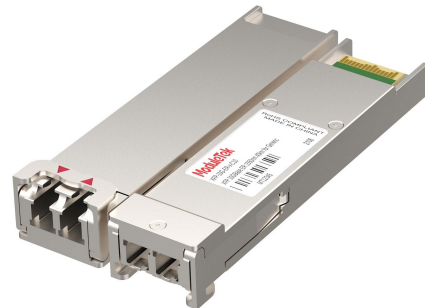

#### Applications

- 10GBASE-ER/EW 10G Ethernet
- 40km 10G Fiber Channel
- OC192 IR-2/STM S-64.2b

## Ordering Information

Part Number	Product ID	Description	Color on Clasp
XFP-10G-ER-C-C10	M254600	10GBASE XFP Transceiver, LC Connectors, 1550nm, Single Mode Fiber 40km, Commercial temperature	Red
XFP-10G-ER-I-C10	M368800	10GBASE XFP Transceiver, LC Connectors, 1550nm, Single Mode Fiber 40km, Industrial temperature	Red
Note: 1.Product ID is the abbreviated order number of our company's standard model			

### For More Information:

ModuleTek Limited

Web : [www.moduletek.com](http://www.moduletek.com)

Email : sales@moduletek.com

## Absolute Maximum Ratings

Parameter	Symbol	Min	Typ	Max	Unit	Remarks
Storage Ambient Temperature	T <sub>S</sub>	-40		85	°C	
Supply Voltage 5V	V <sub>CC5</sub>	-0.5		5.5		
Supply Voltage 3.3V	V <sub>CC3</sub>	-0.5		4	V	

## General Specifications

Parameter	Symbol	Min	Typ	Max	Unit	Remarks
Data Rate	DR	9.95		11.3	Gb/s	
Bit Error Rate	BER			10 <sup>-12</sup>		
Total Power Consumption	P			2.5	W	
Supply Voltage -5V	V <sub>CC5</sub>	4.75	5.0	5.25	V	1
Supply Voltage-3.3V	V <sub>CC3</sub>	3.14		3.46	V	1
Supply Current-V <sub>CC5</sub> supply	I <sub>CC5</sub>			200		
Supply Current-V <sub>CC3</sub> supply	I <sub>CC3</sub>			500	mA	
Operating Temperature	T <sub>C</sub>	0		70	°C	2
	T <sub>I</sub>	-40		85	°C	2

### Notes:

1. Operating Environment
2. Case temperature

## Link Distances

Data Rate	Fiber Type	Distance Range (km)
9.95 –11.3 Gb/s	9/125umSMF	40

## Optical - Characteristics - Transmitter

$V_{CC5}=4.75V$  to  $5.25V, V_{CC3}=3.14V$  to  $3.46V, T_C$

Parameter	Symbol	Min	Typ	Max	Unit	Remarks
Output Optical Power	$P_{TX}$	-4		4	dBm	1
Optical Center Wavelength	$\lambda_C$	1530		1565	nm	
Extinction Ratio	ER	8.2			dB	
Side Mode Suppression Ratio	SMSR	30			dB	
Relative Intensity Noise	RIN			-130	dB/Hz	
Transmitter Dispersion Penalty	TDP			2	dB	
Launch Power of OFF Transmitter	$P_{OUT\_OFF}$			-30	dBm	1
Transmitter Jitter (Peak-to-Peak)	TJ			0.1	UI	

### Notes:

1. Average

## Typical eye diagram

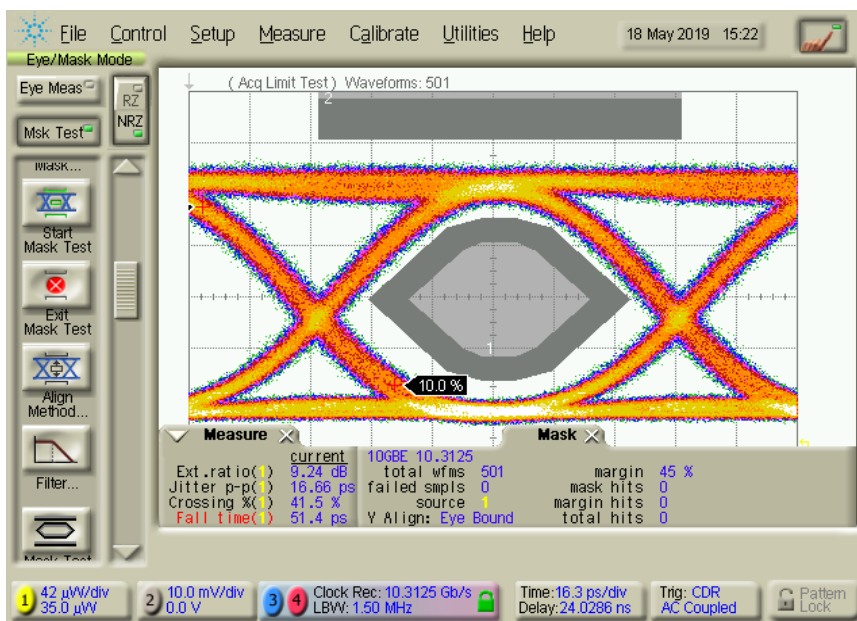

## Optical - Characteristics - Receiver

$V_{CC5}=4.75V$  to  $5.25V$ ,  $V_{CC3}=3.14V$  to  $3.46V$ ,  $T_C$

Parameter	Symbol	Min	Typ	Max	Unit	Remarks
Center Wavelength Range	$\lambda_C$	1260		1600	nm	
Optical Input Power	$P_{RX}$	-16		-1	dBm	
Receiver Sensitivity @10.3Gb/s	$R_{X\_SEN}$			-16	dBm	1
Receiver Reflectance	$TR_{RX}$			-27	dB	
LOS Assert	$LOS_A$	-25			dBm	
LOS De-Assert	$LOS_D$			-18	dBm	
LOS Hysteresis	$LOS_H$	0.5			dB	

### Notes:

1. Measured with worst ER:  $BER < 10^{-12}$ ;  $2^{31}-1$  PRBS

## Electrical - Characteristics - Transmitter

$V_{CC5}=4.75V$  to  $5.25V$ ,  $V_{CC3}=3.14V$  to  $3.46V$ ,  $T_C$

Parameter	Symbol	Min	Typ	Max	Unit	Remarks
Input differential impedance	$R_{IN}$		100		$\Omega$	1
Differential data input swing	$V_{IN\_PP}$	120		820	mV	
Transmit Disable Voltage	$V_D$	2		$V_{CC}$	V	2
Transmit Enable Voltage	$V_{EN}$	GND		GND+0.8	V	
Transmit Disable Assert Time				10	us	

### Notes:

1. After internal AC coupling
2. Or open circuit

## Electrical - Characteristics - Receiver

$V_{CC5}=4.75V$  to  $5.25V$ ,  $V_{CC3}=3.14V$  to  $3.46V$ ,  $T_C$

Parameter	Symbol	Min	Typ	Max	Unit	Remarks
Differential data output swing	V <sub>OUT_PP</sub>	340	650	850	mV	
Data output rise time/fall time (20%-80%)	t <sub>r</sub> /t <sub>f</sub>			38	ps	
LOS Fault	V <sub>LOS_A</sub>	V <sub>CC</sub> -0.5		V <sub>CC_HOST</sub>	V	
LOS Normal	V <sub>LOS_D</sub>	GND		GND+0.5	V	

## A0 Write Protection

Security Level 1 Password		
Password Entry ADDR	Size	Vaues(hex)
Page A0, 7BH-7EH	4	00 00 10 11

This module has the A0 write protection function. The user can enter the security level 1 working state and write the contents of Table 00 and Table 01 of the device address A0H of the module. The method to enter the working state of security level 1 is to write the security level 1 password in order in the 7BH-7EH registers of A0H of the module. After entering security level 1, the user can directly write to the contents of the A0H device address, or modify the contents of the A0H 7F table selection register to write to the contents of Table 00 or Table 01. This version of the module does not support users to modify the password of security level 1. If you need to modify the security level 1 password, you must notify our company to modify it before shipping.

## I2C Memory Map (Page A0 HEX, Unlisted Fields are Blank/Empty)

IIC ADDR	Size	Name	Description	Vaules(HEX)
128	1	Identifier	XFP	06
129	1	Ext. Identifier	1.Power Level 3 Module (3.5W max. power dissipation.) 2.TX Ref Clock Input Not Required	90
130	1	Connector	Connector Type=LC	07
131-138	8	Transceiver	10GBASE-ER	22 20 00 00 00 20 00 00
139	1	Encoding	Code for serial encoding algorithm	F0
140	1	BR-Min	Minimum bit rate, units of 100 MBits/s.	63
141	1	BR-Max	Maximum bit rate, units of 100 MBits/s.	6B
142	1	Length(SMF)-km	40km Link Length in Thousands of Meters / SMF	28
143	1	Length (E-50µm)	Link length supported for EBW 50/125 µm fiber, units of 2 m	00
144	1	Length (50 µm)	Link length supported for 50/125 µm fiber, units of 1 m	00
145	1	Length (62.5 µm)	Link length supported for 62.5/125 µm fiber, units of 1 m	00
146	1	Length(Copper)	Link length supported for copper, units of 1m	00
147	1	Device Tech	1.1550 nm EML 2.Cooled transmitter 3.PIN detector	74
148-163	16	Vendor name	ModuleTek	ASCII Format
164	1	CDR Support	CDR Rate Support	F9
165-167	3	Vendor OUI	XFP vendor IEEE company ID	00 00 00
168-183	16	Vendor PN	Part number provided by XFP vendor (ASCII)	ASCII Format
184-185	2	Vendor Revision Number	Revision level for part number provided by vendor (ASCII)	Programmed by Factory
186-187	2	Wavelength	Nominal laser wavelength (Wavelength = value / 20 in nm)	according to actual wavelength
188-189	1	Wavelength Tolerance	Guaranteed range of laser wavelength (+/- value) from Nominal wavelength. (Wavelength Tol. = value/200 in nm)	0F A0

190	1	Max Case Temp	Maximum Case Temperature in Degrees C.	46
191	1	CC_BASE	Check code for Base ID Fields (addresses 120-190)	Programmed by Factory
192-195	4	Power Supply	Power supply current requirements and max power dissipation	00
196-211	16	Vendor SN	Serial number provided by vendor (ASCII)	00
212-219	8	Date code	Vendor's manufacturing date code	00
220	1	Diagnostic Monitoring Type	Received power measurement type-Average Power	08
221	8	Enhanced Options	1.Optional Soft TX_DISABLE implemented 2.Optional Soft P_down implemented	60
222	1	Aux Monitoring	Auxiliary Input Types: 1.Laser Temperature 2.+5V Supply Voltage	46
223	1	CC_EXT	Check sum of bytes 192-222	F0
224-255	32	Vendor Specific	Vendor Specific	Programmed by Factory

## Digital Diagnostic Functions

ModuleTek’s XFP-10G-ER-x-C10 incorporates a XFP compliant 2-wire management interface which is used for serial ID, digital diagnostics and certain control functions. It is modeled on the SFF-8472 Rev 9.3 specification modified to accommodate a single 2-wire interface address. In addition to the basic I2C read/write functionality the modules support packet error checking that, when enabled, allows the host system to confirm the validity of any read data. Details of the protocol and interface are explicitly described in the MSA. The digital diagnostics provides real-time access to operating parameters via a 2-wire serial interface, including operating temperature, laser bias current, transmitted optical power, received optical power and operating voltage.

Digital Diagnostic Threshold Range					
Parameter		High Alarm(hex)	High Warning(hex)	Low Warning(hex)	Low Alarm(hex)
Temperature(°C)	T <sub>C</sub>	75 (0x4B00)	70 (0x4600)	0 (0x0000)	-5 (0xFB00)
	T <sub>I</sub>	90 (0x5A00)	85 (0x5500)	-40 (0xD800)	-45 (0xD300)
5V Voltage(V)		5.5 (0xD6D8)	5.25 (0xCD14)	4.75 (0xB98C)	4.5 (0xAFC8)
3.3V Voltage(V)		3.63 (0x8DCC)	3.46 (0x8728)	3.13 (0x7A44)	2.97 (0x7404)
1.8V Voltage(V)		1.98 (0x4D58)	1.89 (0x49D4)	1.71 (0x42CC)	1.62 (0x3F48)
Bias Current(mA)		131 (0xFFDC)	130 (0xFDE8)	20 (0x2710)	15 (0x1D4C)
Tx Power(μW)		3014.2 (0x75BE)	2512 (0x621E)	316.2 (0x0C5A)	252.9(0x09E1)
Rx Power(μW)		2000 (0x4E20)	1500 (0x3A98)	23.7 (0x00ED)	15.8 (0x009E)

## Block-Diagram-of-Transceiver

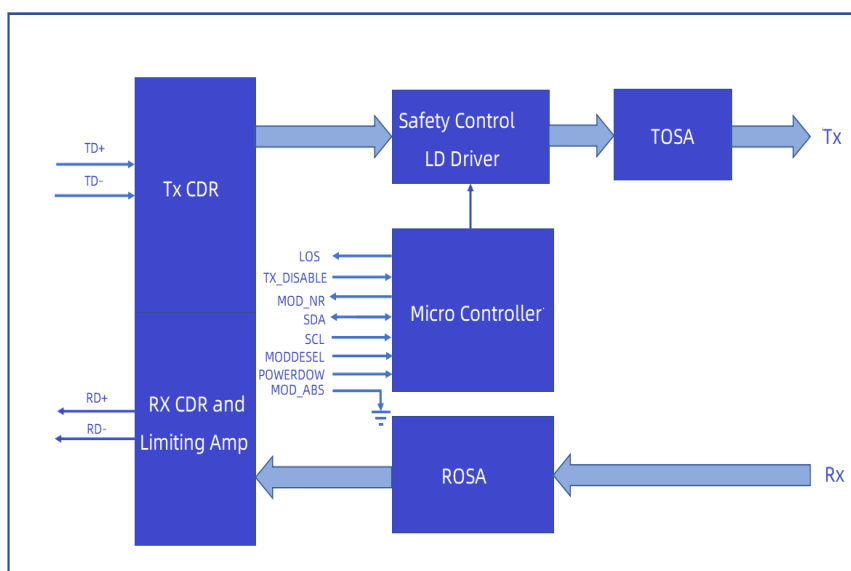

## Functions Description

The transmitter consists of a laser driver chip and a TOSA (light-emitting component). The TOSA includes a laser, an electroabsorption modulator (EAM), a TEC, and a backlight diode. Unlike DML, EML TOSA uses external modulation. When the transmission rate of the system is high, the transmission distance is not only limited by the attenuation of the optical fiber, but also by the dispersion of the optical fiber, and the dispersion of the optical communication system is related to the modulation spectral width. The directly modulated laser has a large dispersion cost, and has spectral broadening, frequency chirp, and short transmission distance, so the external modulation method is adopted in the medium-long-distance transmission at a rate of 10 Gb/s. The TEC (Thermo Electric Cooler) Controls the temperature of the laser tube. When a temperature is set, the TOSA temperature of the module will remain unchanged through the control of the TEC. The wavelength of the module laser tube is related to the temperature of the laser tube. The module wavelength can be set by setting the TOSA temperature. When stable, the module has excellent wavelength stability. The electrical signal enters the optical module from the serial electrical interface and is then input to the laser driver chip. The laser driver chip supplies the bias current and the modulation current to the laser. The laser driver chip simultaneously uses an automatic optical power control (APC) feedback loop to maintain a constant average optical power of the laser output. The purpose is to eliminate the change of the output optical signal due to temperature changes and aging of the light source device. Clock Data Recovery Module (CDR) overcomes board and connector degradation by reshaping, regenerating, and reducing jitter. TX\_DIS is a input pin. When TX\_DIS is asserted High, the XFP module transmitter output must be turned off.

The receiver consists of a ROSA (light-receiving component) and a limiting amplifier chip, ROSA includes a PIN photodetector and a transimpedance amplifier chip. The ROSA detects the incident optical signal, converts the optical signal into an electrical signal, and outputs the electrical signal to the limiting amplifier. The limiting amplifier further amplifies the input signal and outputs a fixed amplitude electrical signal, and then shapes and synchronizes the electrical signal to the host through the CDR. Clock Data Recovery Module (CDR) overcomes board and connector degradation by reshaping, regenerating, and reducing jitter. The RX\_LOS of an output pin, when LOS is high, it indicates insufficient optical power for reliable signal reception. MOD\_NR is an output pin. When it is high, it indicates that the module detects the condition that invalidates the transmitter/receiver data. The transmission signal regulator loses lock, the transmitter laser fails, and the receiver signal regulator loses lock. The micro controller unit initializes the control register of laser driver, limiting amplifier and CDR. It monitors the running information from the laser driver, limiting amplifier and CDR, then reports this information to the customer.

## Dimensions

**Module Weight: 39g**

**Dust Cap Weight: 0.95g**

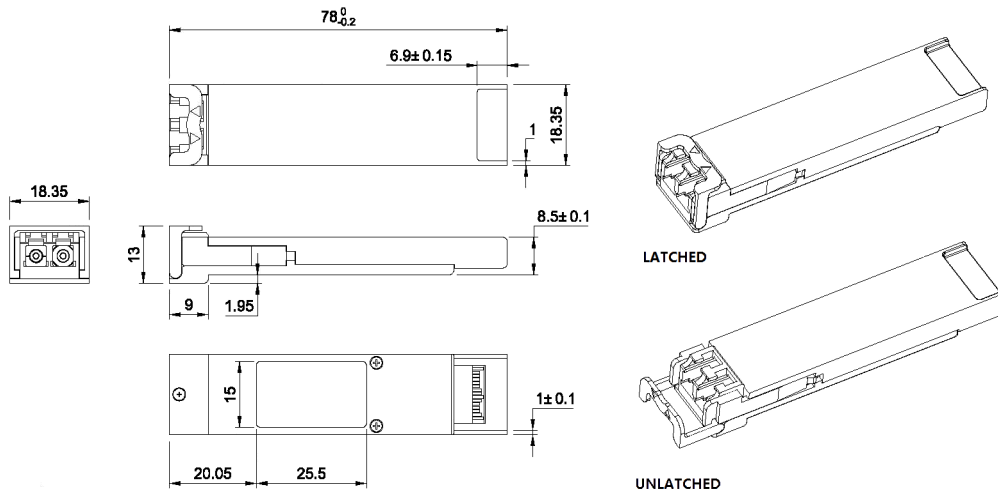

ALL DIMENSIONS ARE  $\pm 0.2$ mm UNLESS OTHERWISE SPECIFIED  
UNIT: mm

## Electrical Pad Layout

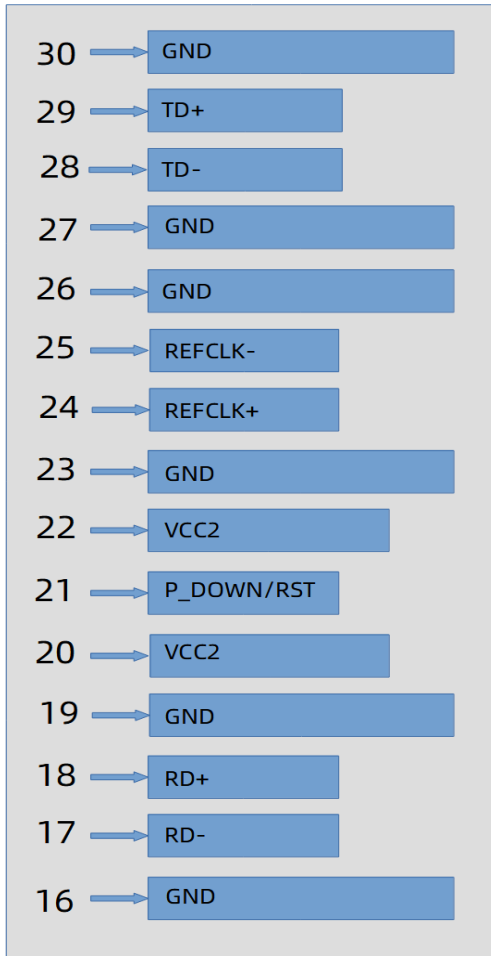

Top of Board

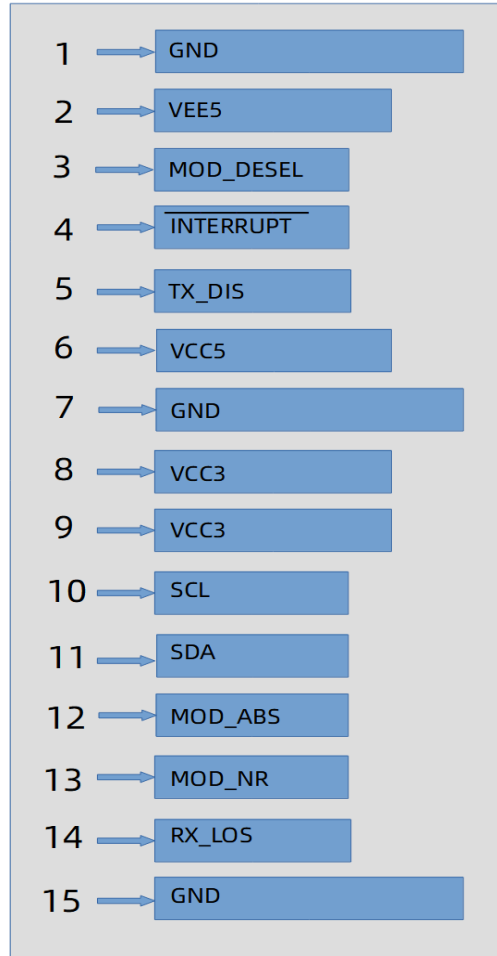

Bottom of Board

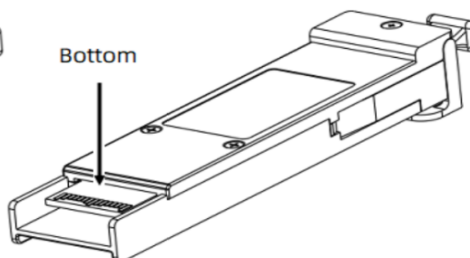
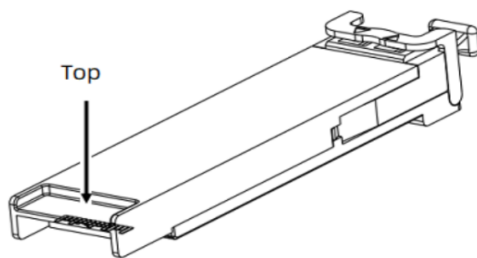

## Pin Assignment - Pin1 to Pin30

PIN #	Symbol	Description	Remarks
1	GND	Module Ground	1
2	VEE5	Optional -5.2 Power Supply (Not required)	
3	Mod-Desel	Module De-select, when held low allows the module to respond to 2-wire serial interface commands	
4	$\overline{\text{Interrupt}}$	Indicates presence of an important condition which can be read over the serial 2-wire interface	2
5	TX_DISABLE	Transmitter Disable, Transmitter laser source turned off	
6	VCC5	+5V Power Supply	
7	GND	Module Ground	1
8	VCC3	+3.3V Power Supply	
9	VCC3	+3.3V Power Supply	
10	SCL	Serial 2-wire interface clock	2
11	SDA	Serial 2-wire interface data line	2
12	Mod_ABS	Module Absent; Indicates module is not present. Grounded in the module	2
13	Mod_NR	Module Not Ready; Indicates module operating fault	2
14	RX_LOS	Receiver Loss of Signal indicator	2
15	GND	Module Ground	1
16	GND	Module Ground	1
17	RD-	Receiver inverted data output	
18	RD+	Receiver non-inverted data output	
19	GND	Module Ground	1
20	VCC2	+1.8V Power Supply	
21	P_Down/RST	Power Down; When high, places the module in the low power stand-by mode and on the falling edge of P_Down initiates a module rest Reset; The falling edge initiates a complete reset of the module including the 2-wire serial interface, equivalent to a power cycle	
22	VCC2	+1.8V Power Supply	
23	GND	Module Ground	1
24	RefCLK+	Reference Clock non-inverted input, AC coupled on the host board	
25	RefCLK-	Reference Clock inverted input, AC coupled on the host board	
26	GND	Module Ground	1

27	GND	Module Ground	1
28	TD-	Transmitter inverted data input	
29	TD+	Transmitter non-inverted data input	
30	GND	Module Ground	1

**Notes:**

1. Module ground pins (GND) are isolated from the module case and chassis ground within the module
2. Open collector, should be pulled up with 4.7k $\Omega$ -10k $\Omega$  on host board to a voltage between 3.15V and 3.6V

**References**

1. 10GBASE Small Form Factor Pluggable Module(XFP)Multi-Source Agreement(MSA), Rev4.5 – August 2005.