

DATA SHEET

MODULETEK: SFP-FC16G-SW-C-E14

14.025Gb/s SFP Short Wavelength (850nm) Transceiver

Overview

SFP-FC16G-SW-C-E14 optical transceiver module is designed for fibre-optic links with data rates up to 14.025Gb/s on MMF. Compliant with FC-PI-5, SFF-8081, SFF-8419, SFF-8432 and SFF-8472. The product implements digital diagnostics via a 2-wire serial bus, compliant with the SFF-8472 standard.

Product Features

- Up to 14.025Gb/s bi-directional data links
- Compliant with FC-PI-5
- Compliant with SFF-8081
- Compliant with SFF-8419
- Compliant with SFF-8432
- Compliant with SFF-8472
- Hot-pluggable SFP footprint
- 850nm VCSEL laser transmitter
- Duplex LC connector
- Built-in digital diagnostic functions
- 100m over M5E MMF (50/125um OM3)
- Single power supply 3.3V
- RoHS-6 Compliant
- Operating temperature range(Case temperature) : Commercial Level : 0°C to 70°C



Applications

- 4.25/8.5/14.025Gb/s Fibre Channel

Ordering Information

Part Number	Product ID	Description	Color on Clasp
SFP-FC16G-SW-C-E14	M600308	16GFC SFP 850nm LC Connectors 100m on MMF, with DOM function	Black
Notes: 1. Product ID is the abbreviated order number of our company's product standard model			
For More Information Or To Order The Above Products, Please Contact: Email: sales@moduletek.com ModuleTek Web: www.moduletek.com			

General Specifications

Parameter	Symbol	Min	Typ	Max	Unit	Remarks
Operating Temperature	T _C	0		70	°C	1
Storage Temperature	T _{STO}	-40		85	°C	2
Supply Current	I _{CC}		145	290	mA	3
Input Voltage	V _{CC}	3.15	3.3	3.46	V	
Maximum Voltage	V _{MAX}	-0.5		4	V	
Power Dissipation	P		550	700	mW	

Notes:

1. Case temperature
2. Ambient temperature
3. For electrical power interface

Link Distances

Parameter	Symbol	Min	Typ	Max	Unit	Remarks
Data rate	DR		4.25 8.5 14.025		Gbps	1
Bit error rate	BER			1×10^{-12}		2
OM2 multimode fiber (bandwidth 500MHz*km)	L			150	m	3
				50		4
				35		5
OM3 multimode fiber (bandwidth 2000MHz*km)	L			380	m	3
				150		4
				100		5
OM4 multimode fiber (bandwidth 4700MHz*km)	L			400	m	3
				190		4
				125		5

Notes:

1. FC-PI-5
2. PRBS 2⁷-1@8GFC, PRBS 2³¹-1@16GFC
3. At 4.25Gb/s Fibre Channel data rate
4. At 8.5Gb/s Fibre Channel data rate
5. At 14.025Gb/s Fibre Channel data rate

Optical Characteristics - Transmitter

V_{CC}=3.15V to 3.46V, T_C=0°C to 70°C

Parameter	Symbol	Min	Typ	Max	Unit	Remarks
Average Output Optical Power	P _{TX}	-7.8		2.4	dBm	
Optical Center Wavelength	λ _C	840	850	860	nm	
Optical Modulation Amplitude 4.25Gb/s 8.5Gb/s 14.025Gb/s	OMA	-6.1 -5.2 -4.8			dBm	

Optical Characteristics - Receiver

$V_{CC}=3.15V$ to $3.46V$, $T_C=0^{\circ}C$ to $70^{\circ}C$

Parameter	Symbol	Min	Typ	Max	Unit	Remarks
Optical Center Wavelength	λ_C	840	850	860	nm	
Average Receiver Power	P_{RX}	-10.3		2.4	dBm	1
Optical Return Loss	ORL	12			dB	
LOS Assert	LOS_A	-30			dBm	
LOS De-Assert	LOS_D			-13	dBm	
LOS Hysteresis	LOS_H	0.5			dB	

Notes:

1. Measured with data rate at 14.025Gbps, PRBS 2³¹-1, BER 1x10⁻¹², without fiber

Electrical Characteristics - Transmitter

$V_{CC}=3.15V$ to $3.46V$, $T_C=0^{\circ}C$ to $70^{\circ}C$

Parameter	Symbol	Min	Typ	Max	Unit	Remarks
Input differential impedance	R_{IN}		100		Ω	
Differential data input swing	V_{IN_PP}	180		1600	mV	
Transmit Disable Voltage	V_D	2		V_{CC}	V	
Transmit Enable Voltage	V_{EN}	V_{EE}		$V_{EE}+0.8$	V	

Electrical Characteristics - Receiver

$V_{CC}=3.15V$ to $3.46V$, $T_C=0^{\circ}C$ to $70^{\circ}C$

Parameter	Symbol	Min	Typ	Max	Unit	Remarks
Differential output swing	V_{OUT_PP}	370	600	850	mV	
LOS Assert	LOS_A	2		V_{CC_HOST}	V	
LOS De-Assert	LOS_D	V_{EE}		$V_{EE}+0.8$	V	

Digital Diagnostic Functions

SFP-FC16G-SW-C-E14 supports the 2-wire serial communication protocol defined in SFF-8472, which accesses digital diagnostic information through a 2-wire interface with the address 0xA2. The digital diagnosis defaults to internal calibration, and the internal micro-control unit accesses the module operating parameters in real time, such as module temperature, laser bias current, emission power, received light power and module power supply voltage. The module realizes the alarm function of SFF-8472, which sets the alarm flag bit when the specific working

parameters are out of the normal range, and cancels the alarm flag bit when the specific working parameters return to the normal range.

Digital Diagnostic Threshold Range

Parameter	High Alarm	High Warning	Low Warning	Low Alarm
Temperature(°C)	75.00(4B00h)	70.00(4600h)	0.00(0000h)	-5.00(FB00h)
Voltage(V)	3.63(8DCCh)	3.46(8728h)	3.13(7A44h)	2.97(7404h)
Bias Current(mA)	12.00(1770h)	11.50(1676h)	2.00(03E8h)	1.00(01F4h)
Tx Power(dBm)	3.40(5575h)	2.40(43E2h)	-8.40(05A5h)	-9.40(047Ch)
Rx Power(dBm)	3.40(5575h)	2.40(43E2h)	-10.30(03A5h)	-11.30(02E5h)

A0h, A2h Write Protection

Security Level 1 Password (Factory value)		
Password Entry ADDR	Size	Vaules(HEX)
Page A2h, 7Bh-7Eh	4	00 00 10 11
Change Security Level 1 Password		
Change Password Entry ADDR	Size	Vaules(HEX)
Page A2h, Table F0h, 80h-83h	4	Programmed by User

SFP-FC16G-SW-C-E14 has write protection functions of A0h and A2h, and users can enter the working state of security level 1 and write to the address of module device A0h and table 00h, table 01h and table F0h of A2h. The method to enter the working state of security level 1 is to write the security level 1 password in the 7Bh-7Eh register of the module A2h address in turn. After entering the security level 1, the user can directly write the contents of the A0h device address, or by modifying the contents of the 7Fh table selection register in the A2h address, write to table 00h or table 01h or table F0h. This version module supports users to modify the password of security level 1 by writing a new security level 1 password in the 80h-83h register in the device address F0h table of module A2h.

IIC Memory Map(Page A0 HEX, Unlisted Fields are Blank/Empty)

IIC ADDR	Size	Name	Description	Vaules(HEX)
0	1	Identifier	SFP	03
1	1	Ext. Identifier	Two-wire Interface	04
2	1	Connector	Connector Type = LC	07
3-10	8	Transceiver	16G FC SW	10 00 00 00 60 40 0C 70

11	1	Encoding	Code for high speed serial encoding 64B/66B	06
12	1	BR, Nominal	Nominal Bit Rate 14.025Gbps	8C
13	1	Rate Identifier	Type of rate select functionality	0A
14	1	Length(9um)-km	Link Length in Thousands of Meters/SMF = NA	00
15	1	Length(9um)-100m	Link Length in Hundreds of Meters/SMF = NA	00
16	1	Length(50um)-10m	50-micron MMF Link Length = 35	04
17	1	Length(62.5um)-10m	62.5-micron MMF Link Length = 15	02
18	1	Length(OM4)-10m	125m Link Length in OM4 MMF	0D
19	1	Length(OM3)-10m	100m Link Length in OM3 MMF	0A
20-35	16	Vendor name	MODULETEK	ASCII Format
36	1	Transceiver	16G FC SW	00
37-39	3	Vendor OUI	SFP Vendor IEEE Company ID	00 00 00
40-55	16	Vendor PN	Part number provided by SFP vendor	ASCII Format
56-59	4	Vendor rev	Revision level for part number provided by vendor	Programmed by Factory
60-61	2	Wavelength	Laser Wavelength = 850nm	03 52
62	1	Reserved	Unallocated	00
63	1	CC_BASE	Check sum of bytes 0-62	Programmed by Factory
64	1	Transceiver Options	BIT7=0 Reserved BIT6=0 Reserved BIT5=0 The module power level is 1 (Less than 1.0w) BIT4=1 Paging implemented function BIT3=1 Retimer or CDR indicator BIT2=0 A uncooled laser transmitter implementation BIT1=0 The module power Level is 1 (Less than 1.0w) BIT0=0 A conventional limiting receiver output	18
65	1	Transceiver Options	BIT7=0 Receiver decision threshold implemented is not realized BIT6=0 Tunable wavelength lasers are not used BIT5=1 RATE_SELECT functionality is realized BIT4=1 Have TX_DIS function BIT3=1 Have TX_Fault function BIT2=0 Loss of Signal is not realized BIT1=1 Have RX_LOS function BIT0=0 Reserved	3A
66	1	BR, max	Maximum signal rate, unused	00
67	1	BR, min	Minimum signal rate, unused	00
68-83	16	Vendor SN	Vendor SN	Programmed by Factory

84-91	8	Date code	Year, Month, Day	Programmed by Factory
92	1	Diagnostic Monitoring Type	BIT7=0 Compatible with SFF-8472 requirements BIT6=1 Realize digital diagnostic function BIT5=1 Realized internal calibration function BIT4=0 Externally calibration is not realized BIT3=1 Received power is the averaged power BIT2=0 Don't need address change BIT1=0 Reserved BIT0=0 Reserved	68
93	1	Enhanced Options	BIT7=1 Have optional Alarm/Warning flags implements function BIT6=1 Have soft TX_DIS monitor and control functions BIT5=1 Have soft TX_Fault monitor function BIT4=1 Have soft RX_LOS monitor function BIT3=1 Have software RATE_SEL monitor and control functions BIT2=0 The optional soft rate selection control funtion is not implemented by SFF-8079 BIT1=1 The optional soft rate selection control funtion is implemented by SFF-8431 BIT0=0 Reserved	FA
94	1	SFF-8472 Compliance	As defined by SFF8472 version 12.3	08
95	1	CC_BASE	Check sum of bytes 64-94	Programmed by Factory
96-127	32	Vendor Specific	Vendor Specific EEPROM	Programmed by Factory
128-255	128	Reserved	Vendor Specific	Programmed by Factory

IIC Memory Map(Page A2 HEX LOW, Unlisted Fields are Blank/Empty)

IIC ADDR	Size	Name	Description	Vaules(HEX)
Alarm/Warning Thresholds				
00-01	2	Temp High Alarm	Temperature high alarm	See Table Of Threshold Ranges
02-03	2	Temp Low Alarm	Temperature low alarm	See Table Of Threshold Ranges
04-05	2	Temp High Warning	Temperature high warning	See Table Of Threshold Ranges
06-07	2	Temp Low Warning	Temperature low warning	See Table Of Threshold Ranges

08-09	2	Voltage High Alarm	Voltage high alarm	See Table Of Threshold Ranges
10-11	2	Voltage Low Alarm	Voltage low alarm	See Table Of Threshold Ranges
12-13	2	Voltage High Warning	Voltage high warning	See Table Of Threshold Ranges
14-15	2	Voltage Low Warning	Voltage low warning	See Table Of Threshold Ranges
16-17	2	Bias High Alarm	Bias current high alarm	See Table Of Threshold Ranges
18-19	2	Bias Low Alarm	Bias current low alarm	See Table Of Threshold Ranges
20-21	2	Bias High Warning	Bias current high warning	See Table Of Threshold Ranges
22-23	2	Bias Low Warning	Bias current low warning	See Table Of Threshold Ranges
24-25	2	TX Power High Alarm	TX power high alarm	See Table Of Threshold Ranges
26-27	2	TX Power Low Alarm	TX power low alarm	See Table Of Threshold Ranges
28-29	2	TX Power High Warning	TX power high warning	See Table Of Threshold Ranges
30-31	2	TX Power Low Warning	TX power low warning	See Table Of Threshold Ranges
32-33	2	RX Power High Alarm	RX power high alarm	See Table Of Threshold Ranges
34-35	2	RX Power Low Alarm	RX power low alarm	See Table Of Threshold Ranges
36-37	2	RX Power High Warning	RX power high warning	See Table Of Threshold Ranges
38-39	2	RX Power Low Warning	RX power low warning	See Table Of Threshold Ranges
40-55	16	Optional A/W Thresholds	Unrealized	-

Calibration Constant For External Calibration Option				
56-59	4	RX-PWR(4)	The module only realizes internal correction funtion	00 00 00 00
60-63	4	RX_PWR(3)	The module only realizes internal correction funtion	00 00 00 00
64-67	4	RX_PWR(2)	The module only realizes internal correction funtion	00 00 00 00
68-71	4	RX_PWR(1)	The module only realizes internal correction funtion	3F 80 00 00
72-75	4	RX_PWR(0)	The module only realizes internal correction funtion	00 00 00 00
76-77	2	TX_I(Slope)	The module only realizes internal correction funtion	01 00
78-79	2	TX_I(Offset)	The module only realizes internal correction funtion	00 00
80-81	2	TX_PWR(Slope)	The module only realizes internal correction funtion	01 00
82-83	2	TX_PWR(Offset)	The module only realizes internal correction funtion	00 00
84-85	2	T(Slope)	The module only realizes internal correction funtion	01 00
86-87	2	T(Offset)	The module only realizes internal correction funtion	00 00
88-89	2	V(Slope)	The module only realizes internal correction funtion	01 00
90-91	2	V(Offset)	The module only realizes internal correction funtion	00 00
92-94	3	Unallocated	-	00 00 00
95	1	Checksum	Byte 95 contains the low order 8 bits of the sum of bytes 0-94	-
A/D Values And Status Bits				
96-97	2	Temperature MSB/LSB	Temperature measured value	Variable
98-99	2	Vcc MSB/LSB	Voltage measured value	Variable
100-101	2	Tx Bias MSB/LSB	Bias current measured value	Variable
102-103	2	TX Power MSB/LSB	Measured TX output power	Variable
104-105	2	RX Power MSB/LSB	Measured RX input power	Variable
106-107	2	Laser T/W MSB/LSB	Function not implemented	00 00
108-109	2	TEC current MSB/LSB	Function not implemented	00 00

110	1	Status/Control	BIT7 TX_Dis Pin States BIT6 Soft TX_Dis Pin States BIT5 RS(1) Pin States BIT4 RS0 Pin States BIT3 Soft RS0 control bit BIT2 TX_Fault Pin States BIT1 Rx_LOS Pin States BIT0 Data_Ready_Bar Pin States	Variable
111	1	Reserved	Reserved for SFF-8079	00
112	1	Alarm Flags	BIT7 Temp High Alarm BIT6 Temp Low Alarm BIT5 Vcc High Alarm BIT4 Vcc Low Alarm BIT3 TX Bias High Alarm BIT2 TX Bias Low Alarm BIT1 TX Power High Alarm BIT0 TX Power Low Alarm	Variable
113	1	Alarm Flags	BIT7 RX Power High Alarm BIT6 RX Power Low Alarm BIT5-BIT2 Alarm bit not realized BIT1-BIT0 Reserved	Variable
114	1	Tx Input EQ Control	BIT7-BIT4 High-speed mode input equalization setting value; the default value for power-up is 2, which can be used to change the module input equalization value BIT3-BIT0 Low-speed mode input equalization setting value; the default value for power-up is 2, which can be used to change the module input equalization value	22
115	1	Rx Out Emphasis Control	BIT7-BIT4 High-speed mode output emphasis setting value; the default value for power-up is 2, which can be used to change the module output emphasis value BIT3-BIT0 Low-speed mode output emphasis setting value; the default value for power-up is 2, which can be used to change the module output emphasis value	22
116	1	Warning Flags	BIT7 Temp High Warning BIT6 Temp Low Warning BIT5 Vcc High Warning BIT4 Vcc Low Warning BIT3 TX Bias High Warning BIT2 TX Bias Low Warning BIT1 TX Power High Warning BIT0 TX Power Low Warning	Variable
117	1	Warning Flags	BIT7 RX Power High Warning BIT6 RX Power Low Warning BIT5-BIT2 Warning bit not realized BIT1-BIT0 Reserved	Variable
118	1	Ext Status/Control	BIT7-BIT4 BIT2 Reserved BIT3 Soft RS(1) control bit BIT1=0 The module power level is 1 (Less than 1.0w) BIT0=0 The module power level is 1 (Less than 1.0w)	The default for power-up is 00

119	1	Ext Status/Control	BIT7-BIT5 Unallocated BIT4=0 Not Applicable BIT3=0 Not Applicable BIT2=0 Not Applicable BIT1 TX CDR status bit, a value of 0 indicates that the CDR is locked, whereas a value of 1 indicates loss of lock of the CDR BIT0 Rx CDR status bit, a value of 0 indicates that the CDR is locked, whereas a value of 1 indicates loss of lock of the CDR	Variable
General Use Fields				
120-122	3	Reserved	Reserved	00 00 00
123-126	4	Security Level Password	Security level password input area, the written password can be displayed and the default value is 00 00 00 00	00 00 00 00
127	1	Table Select	Table Select	00

Block-Diagram-of-Transceiver

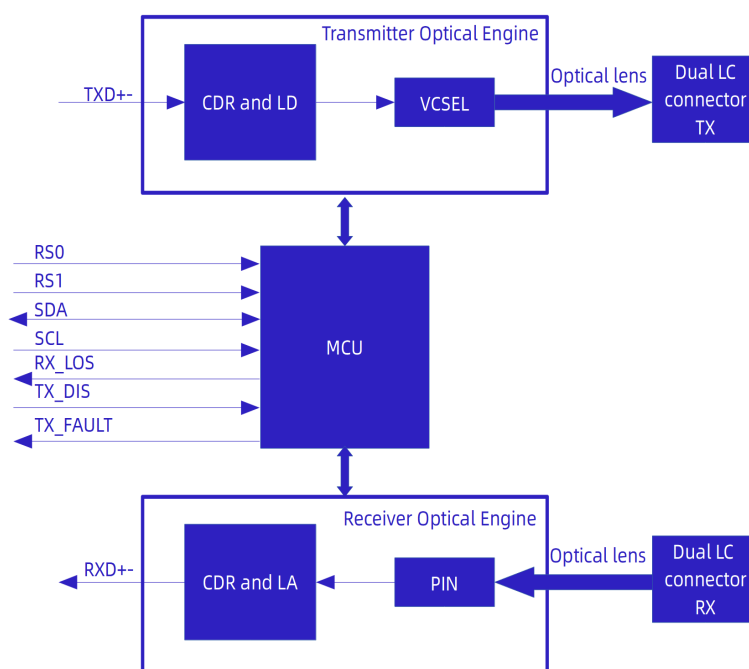

Functions Description

SFP-FC16G-SW-C-E14 module is manufactured using an advanced COB (Chip on Board) process. It consists of a microcontroller, a transmitter optical engine and a receiver optical engine.

Microcontrollers communicate with the host via a 2-wire serial communication interface, providing module control, status reporting and monitoring (DOM), which is SFF-8472 compliant.

The transmitter optical engine includes a transmitter clock data recovery circuit (CDR) and a

laser driver circuit (LD), a VCSEL laser, and a detection photodiode (MPD). The high-speed differential electrical signal output by the host computer is restored and shaped by the CDR, which is amplified by the laser driver to drive the VCSEL laser to produce the optical signal, and the optical signal is coupled to the optical fiber through the optical lens. The optical engine integrates a photodiode for detection, which is used for output optical power detection.

The receiving optical engine includes a photodiode (PIN), a signal amplifier (TIA/LA) and a receiver clock data recovery circuit (CDR). The optical signal in the optical fiber is coupled to the receiving photodiode (PIN) through an optical lens and converted into photocurrent. After the photocurrent signal is enhanced by the amplifier, it is sent to the CDR circuit and the clock and data signal recovery is completed. Finally, it is output to the host in the form of high-speed differential signal. The microcontroller reads the signal strength (modulation amplitude) received by the photodiode and reports the loss of the received signal if it is lower than the set threshold.

Both the transmitter and receiver have the function of suppression. When there is a signal input at the transmitter, the waveform displayed by the transmitted light access oscilloscope is an eye graph shape, and when there is no signal input, the waveform displayed by the transmitted light access oscilloscope is a straight line, and the actual measured optical power is lower than the normal optical power value, but not zero. When the incident light at the receiving has a signal input, the access oscilloscope shows that the waveform of the output electrical signal is an eye graph shape, and when there is no signal input, the oscilloscope shows that the waveform of the output electrical signal is a straight line.

Rate selection control: Rx and Tx rates are controlled by pins 7(RS0) and 9(RS1) respectively, and product rate selection functions are implemented in the following table:

RS0 Pin Level	A2h.110.bit3	Logical OR of RS0 Pin and Bit110.3 of A2H	RX Signal Rate	Status of RX CDR
Low Level	0	0	4.25/8.5Gb/s	CDR Bypassed
Low Level	1	1	14.025Gb/s	CDR Engaged
High Level	0	1	14.025Gb/s	CDR Engaged
High Level	1	1	14.025Gb/s	CDR Engaged

RS1 Pin Level	A2h.118.bit3	Logical OR of RS1 Pin and Bit118.3 of A2H	TX Signal Rate	Status of TX CDR
Low Level	0	0	4.25/8.5Gb/s	CDR Bypassed
Low Level	1	1	14.025Gb/s	CDR Engaged
High Level	0	1	14.025Gb/s	CDR Engaged
High Level	1	1	14.025Gb/s	CDR Engaged

Dimensions

Module Weight: 20.0g
Dust Cap Weight: 0.9g

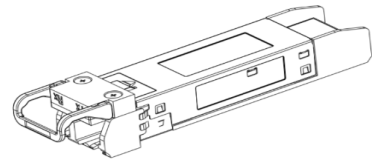
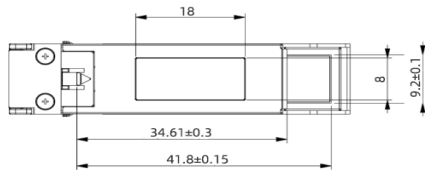
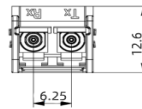
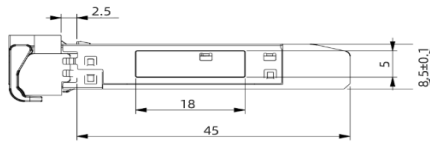
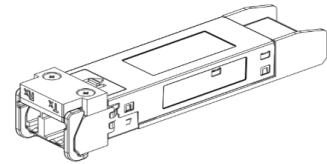
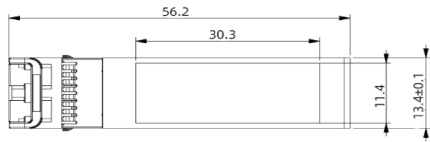

ALL DIMENSIONS ARE ± 0.2 mm UNLESS OTHERWISE SPECIFIED
UNIT: mm

Electrical Pad Layout

Top View Of Board

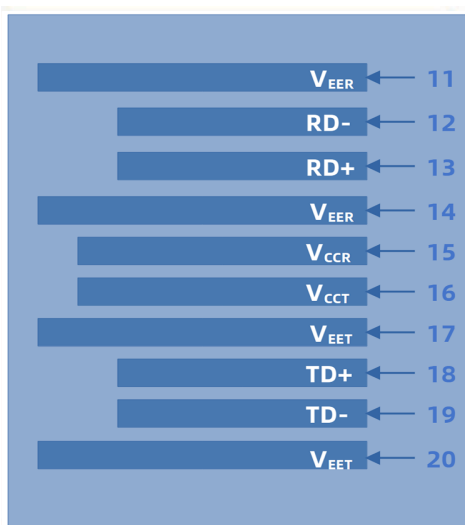

Bottom View Of Board

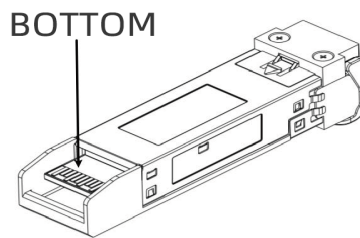
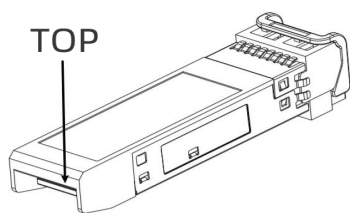
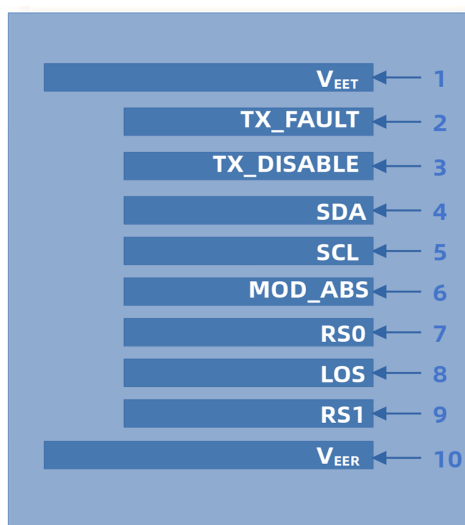

Typical Eye Diagram

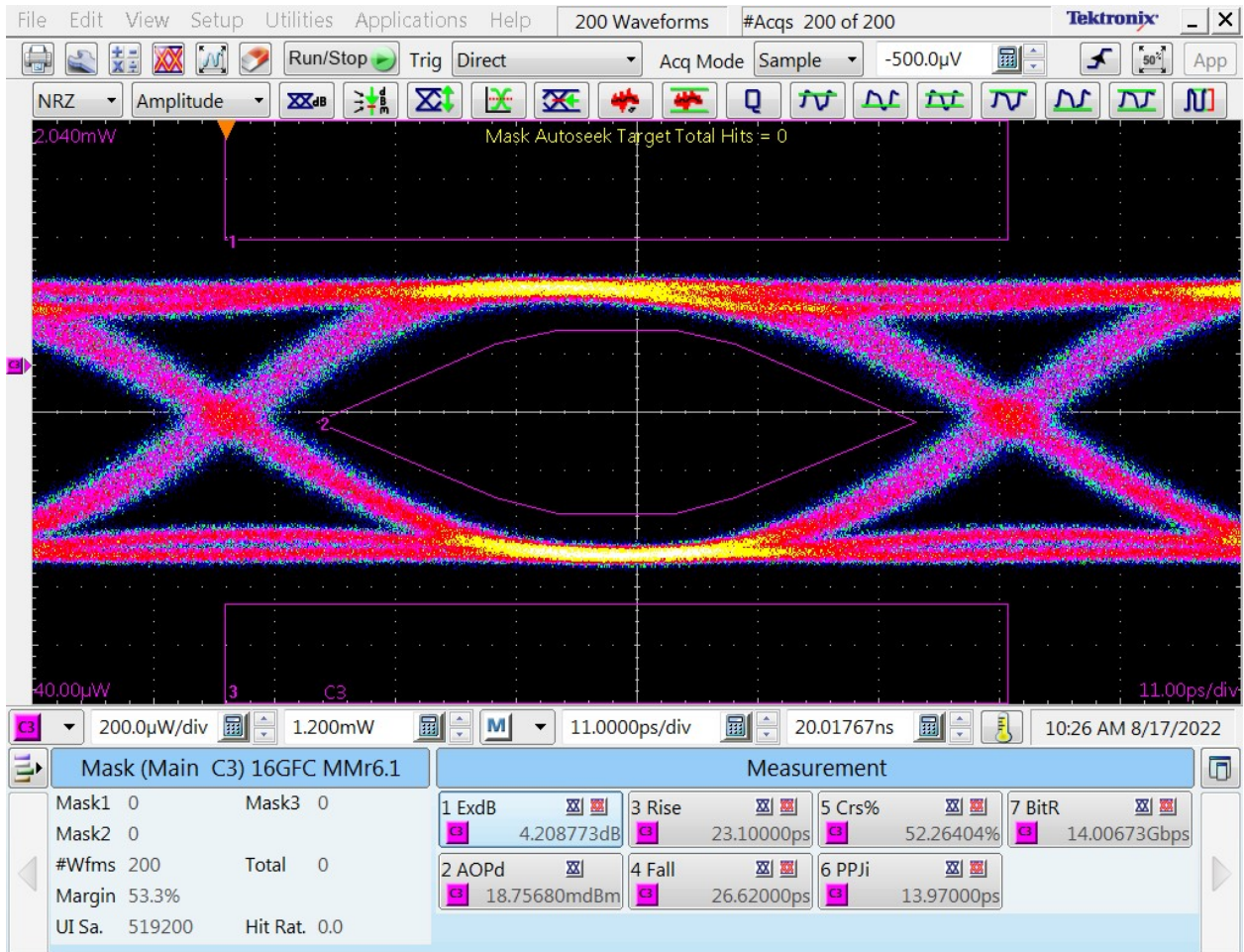

Pin Assignment

PIN #	Symbol	Description	Remarks
1	V _{EET}	Transmitter ground (common with receiver ground)	1
2	TX_FAULT	Transmitter Fault	
3	TX_DISABLE	Transmitter Disable. Laser output disabled on high or open	2
4	SDA	2-wire Serial Interface Data Line	3
5	SCL	2-wire Serial Interface Clock Line	3
6	MOD_ABS	Module Absent. Grounded within the module	3
7	RS0	Receiver rate selection: Open or Low level = 8.5 or 4.25Gb/s Fibre Channel (low bandwidth) High level = 14.025Gb/s Fibre Channel (high bandwidth)	
8	LOS	Loss of Signal indication. Logic 0 indicates normal operation	4
9	RS1	Transmitter rate selection: Open or Low level = 8.5 or 4.25Gb/s Fibre Channel (low bandwidth) High level = 14.025Gb/s Fibre Channel (high bandwidth)	
10	V _{EER}	Receiver ground (common with transmitter ground)	1
11	V _{EER}	Receiver ground (common with transmitter ground)	1
12	RD-	Receiver Inverted DATA out. AC coupled	
13	RD+	Receiver Non-inverted DATA out. AC coupled	
14	V _{EER}	Receiver ground (common with transmitter ground)	1
15	V _{CCR}	Receiver power supply	
16	V _{CCT}	Transmitter power supply	
17	V _{EET}	Transmitter ground (common with receiver ground)	1
18	TD+	Transmitter Non-Inverted DATA in. AC coupled	
19	TD-	Transmitter Inverted DATA in. AC coupled	
20	V _{EET}	Transmitter ground (common with receiver ground)	1

Notes:

1. Circuit ground is isolated from chassis ground
2. Disabled: T_{DIS} > 2V or open, Enabled: T_{DIS} < 0.8V
3. Should Be pulled up with 4.7k – 10k ohm on host board to a voltage between 2V and 3.6V
4. LOS is open collector output

References

1. FIBRE CHANNEL Physical Interface-5 (FC-PI-5). Rev6.00 September 21, 2010
2. SFF-8081 SFP+ 1X 16 Gb/s Pluggable Transceiver Solution (SFP16). Rev1.4 September 13, 2014
3. SFF-8419 SFP+ Power and Low Speed Interface. Rev1.3 June 11, 2015
4. SFF-8432 SFP+ Module and Cage. Rev5.2a November 30, 2018
5. SFF-8472 Management Interface for SFP+. Rev12.3 July 29, 2018